



Lutér®

PULL HANDLE

STAINLESS STEEL DEADBOLT

PROVIDES A CLEAN, STREAMLINED LOOK
SIMPLE DOOR INSTALLATION
CUSTOM SIZES FOR VARIETY NEED



Your best choice

www.luter.com.tw

STAINLESS STEEL DEADBOLT PULL HANDLE

EASY/COZY LOVELY DESIGN

MODERN-STYLE BEST-QUALITY HIGH-TECHNIQUE

Deadbolt pull handle is applicable to glass door, glass door with aluminum frame, and wood doors. SUS 304 and 316 material and CNC process provides a stronger intensity and lasting for gear and pull handle. The Infinity T bar pull handle creates a contemporary look to both an office or home interior.

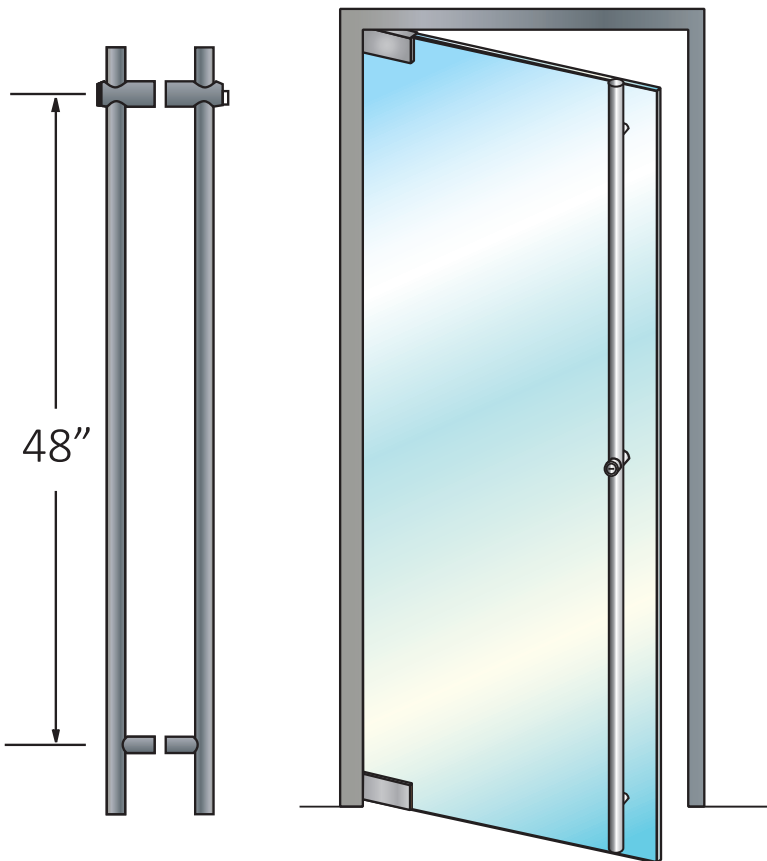

FETURES

MATERIAL \ SUS304 or SUS316

MULTI-FUNCTIONS TO SUIT DIFFERENT POSITION

MULTI-LOCKING OPTIONS \ floor, head or both

CYLINDER OPTIONS \ KABA, Luter L6 dimple, and schlage C keyway.

LENGTH \ STD 1250mm or Custom made

DOOR THICKNESS \ Glass door : 8 - 12 mm
Aluminum door and Wood door need custom made.

60mm Bolt projection face of door

to Centerline of Bolt

50.8mm Bolt throw

with fine adjustable

Available

finish: US32 and US32D

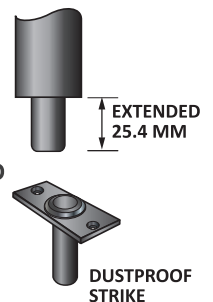

WHY DEADBOLT PULL HANDLE?

Deadbolt pull handle conforms to human ergonomics. 48" distance between cylinder/ thumbturn and floor surface eliminates physical strain and simplify locking and unlocking process, while design facilitates mounting.

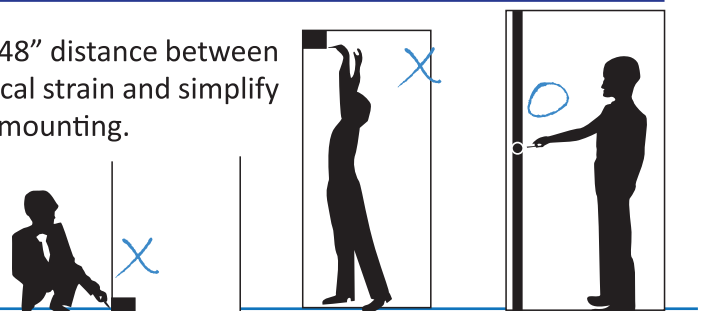

APPLICATION DETAILS FOR GLASS DOORS

Strong fasteners securely attach the pull to the door for a durable and zero trouble installation.

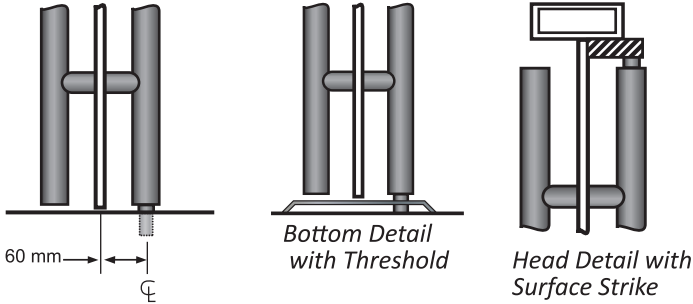

Bolt Projection Face of Door to Centerline of Bolt

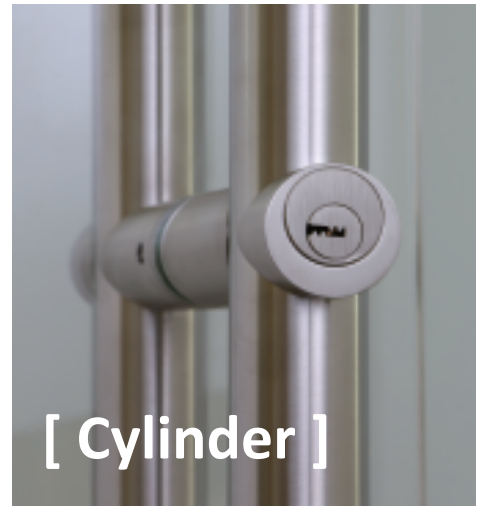

[Cylinder]



[Thumb Turn]

STAINLESS STEEL DEADBOLT PULL HANDLE

OTHER DOORS

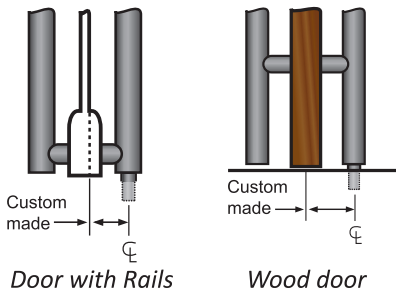

MULTI LOCKING MODELS CHOOSE FROM 3 WAYS

*Bolt up
one point lock*

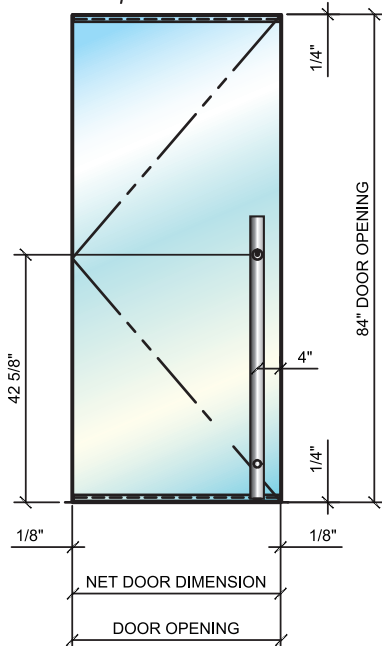



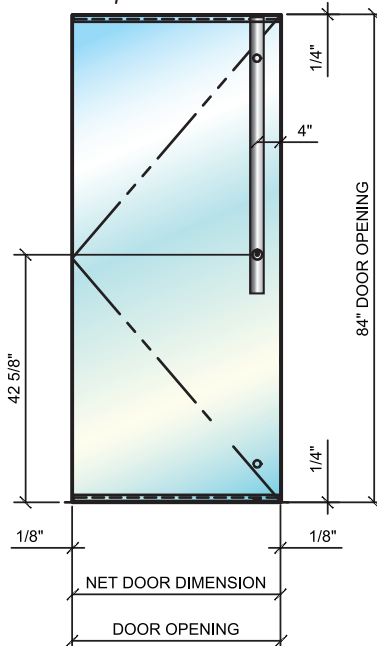

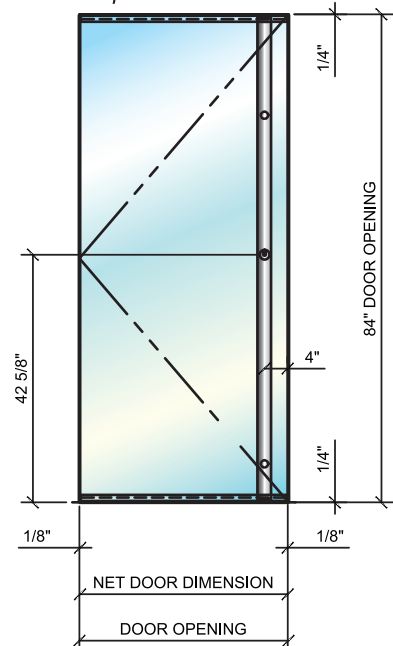

*Bolt down
one point lock*



*Bolt up and down
two points lock*



FUNCTION CODE

CODE	OUTSIDE	INSIDE	NOTE
01			Outside key cylinder with inside thumb turn
02			Double key cylinder
03		NONE	Outside key cylinder only
04	NONE		Inside thumb turn only

HOW TO ORDER

IDENTIFICATION OF PRODUCT

GH	01	1	1250	12	US32D
SERISE	FUNCTION Ref. above Function code	LOCKING WAY 1. One point lock 2. Two points lock	LENGTH 1. STD 1250mm 2. Custom-made Dimension (Please provide dimension for us)	DOOR THICKNESS Glass door : 8 - 12 mm (STD) Aluminum door: Custom-made Wood door need: Custom-made (Please provide dimension for us)	FINISH 1. US32D 2. US32

Lutér®

LUTER ENTERPRISE CO., LTD.

Add. : No.59, Alley 6-6, Lane298, Beitun Rd.,
Beitun District, Taichung City 406, Taiwan(R.O.C.)

Tel : +886-4-22479015

Fax : +886-4-22414361

www.luter.com.tw

E-mail: louis chou@luter.com.tw

DEALEAR